

GB

User Instruction

devireg™ 540/550

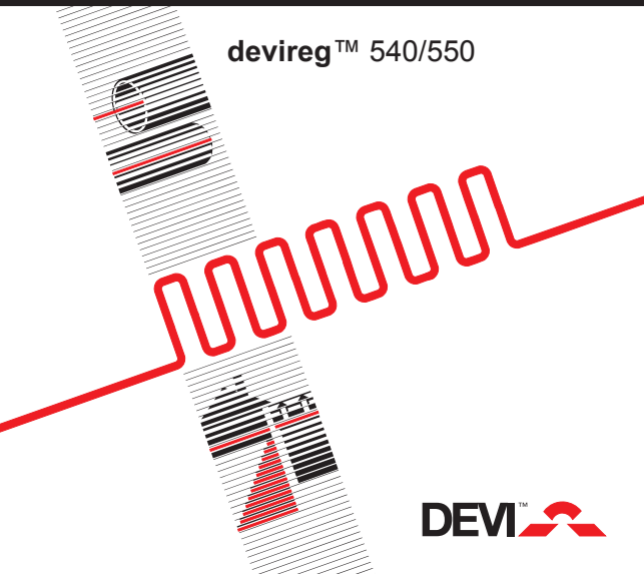

DEVI™ 

Table of contents

Introduction	3
Introducing devireg [™] 540/550	4
How to use your deviheat [™] heating system	6
Daily operation	7
Setting the clock & day	10
Timer programming	11
Warranty	16

Do not cover the thermostat, e.g. by hanging towels etc. directly in front of it !

Introduction

You have purchased a **devireg**[™] 540/550 thermostat, which forms an integrated part of a **deviheat**[™] system.

DEVI[™] has developed the **devireg**[™] 540/550 to make your floor heating an even more environmentally correct way of heating your home.

devireg[™] 540/550 will work dynamically with both the room and floor temperature in order to give you the highest possible comfort in the most economical way.

devireg[™] ***550 ONLY:***

Furthermore, **devireg**[™] 550 will take a few days to optimise the use of the heating system, but it does not stop there. The **devireg**[™] 550 will continue to learn from the room and thus constantly improve its performance and consequently your comfort and economy.

We wish you many years of comfort with your new **deviheat**[™] system.

Introducing **devireg**™ 540/550

devireg™ 540 is an advanced temperature controller, with a built-in Timer.

devireg™ **550 ONLY:**

devireg™ 550 is an adaptive temperature controller, specially designed for floor heating systems.

The **devireg**™ 550 will measure the radiant comfort from the floor combined with the comfort from the air temperature in the room to offset the outside weather condition.

We as human beings perceive comfort as the combined effect of the radiant heat from the floor and air temperature in the room. By continually measuring this combined effect, it is therefore possible to maintain the highest possible comfort level.

A higher floor radiant temperature can produce a sense of comfort with a lower air temperature which can result in lower running costs without reducing comfort levels.

All this means that as soon as you have set your **devireg™** 550 at your desired comfort temperature, you do not have to do anything else. **devireg™** 550 will automatically adjust the heating to meet your requirements for comfort and economy, no matter how the weather is changing outside. This also means that **devireg™** 550 is capable of detecting a sudden temperature drop in the room. Instead of switching the heating on to immediately compensate, the **devireg™** 550 uses the information stored then checks to see if this is caused by e.g. the effects of a window opened for 10 minutes !

Even the programming of economy temperatures (i.e. during the night) is very simple. You do not have to calculate how much earlier the heating should start in order to reach a specific temperature at a specific time. Just tell the **devireg™** 550 when you want the comfort temperature and the **devireg™** 550 will take care of the rest. By learning the rate of heat loss from the room, the **devireg™** 550 knows when to start heating in order to achieve the selected temperature at exactly the right time.

How to use your deviheat™ heating system

The function of the button

The button can be turned both ways, is indicated by



or the button can be pressed/held, is indicated by



View of symbols in the display

Symbol for Timer On

Symbol for frost protection

Numerical display for time, temperature, text, etc.

Weekdays

Flashing point for actual time

Symbol for setting of clock

Symbol for temperature below set-point

Symbol for degrees

Indication of AM/PM time at 12 hour clock

24 hour clock-ring which shows actual time and timer programme

Symbol for Timer programming

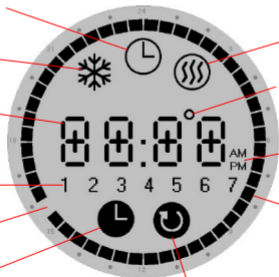

Daily operation

devireg™ 540/550 has two temperature settings:

Constant temperature with the timer off.
Can be used e.g. as 'Party Mode' or for constantly lowering the temperature when going on holiday. This is indicated by a continuous clock ring ...



Timer setting with automatic switching between economy and comfort temperature.
Clock and timer must be set !
Is indicated by the timer symbol and the clock ring showing the timer programme ...



(Display will indicate same temperature during both comfort and economy periods. But temperature will, during economy periods, be lowered according to the set-back level.)

You want to raise the temperature ...

Turn clockwise to raise the temperature.

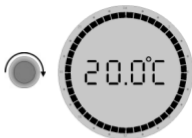

You want to lower the temperature ...

Turn counter-clockwise to lower the temperature.



You want to switch on or off the timer function ...

Press the button to switch on the timer. Press again to switch off the timer.

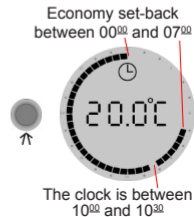

The marking on the clock-ring indicates when comfort temperature is chosen and when economy set-back is switched on. A flashing point indicates the actual clock (every half hour).

If the temperature is lowered to minimum (+5°C), a frost symbol will appear in the display, indicating that the thermostat will maintain minimum +5°C in the room for frost protection.

If the temperature is turned below +5°C, the thermostat will switch off. (Only possible with the timer off)
When the temperature is raised again the thermostat will automatically switch on.

If the **devireg**TM 540/550 only uses a floor sensor, the display will not show the actual temperature (5° to 35°), but a scale from 0 to 10.

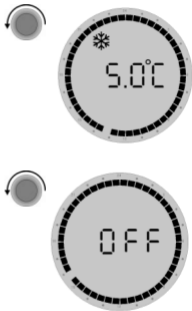

Setting the clock & day

You want to set/change the clock ...
(The clock is not set from the factory)

Hold the button for 3 sec.

The clock can now be set forward or back by turning the button to the right or left respectively.

Changing the week day is done by continuing to change the time until it passes 0:00, either way. The numbers 1-7 do not correspond to any specific days, so you can choose which day of the week is No. 1 etc.

When the clock is set correctly, press the button to save the settings.

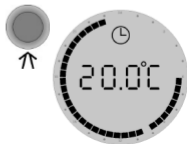

Timer programming

You want to set/change the economy set-back programme ...
(The timer is not set from the factory)

Hold the button for 6 sec. The programme for economy set-back can now be edited.

First, turn the button to choose the weekday which you want to programme ...

Press the button to start the programming ...

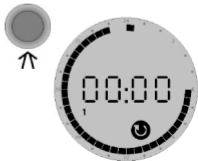

The button is alternately turned and pressed to choose periods with economy set-back and periods with comfort temperature respectively.

The programming switches between low (economy set-back) and high (comfort) temperature every time you press the button.

And between every time you press, you can turn the button and choose the period of time.



Example

When you enter the programming menu choose a day and press the button ...

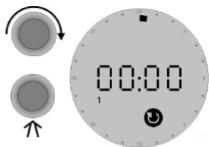

Turn until you reach the first time when you want comfort temperature, e.g. 06:00. Press ...



Turn until the temperature must be lowered again, e.g. 07:30. Press ...

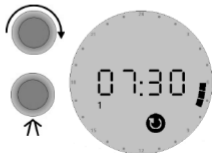

And turn to the next comfort period, e.g. 15:30, and press ...

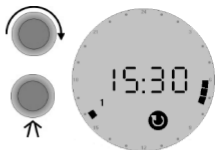

Then, turn until you reach the time when the next lowering of the temperature must start, e.g. 22:30, and press ...



If you continue to turn, the programme will automatically continue with the next day.



This way, the programming can continue for the entire week.

End

When you have ended the programming, the changes must be saved.



↑
3 sec.



This is done by holding the button for 3 sec. The display will automatically return to normal display.

Remember (*devireg*[™] 550 ONLY):

With *devireg*[™] 550 you only have to programme the time when you want comfort temperature and the time you want economy temperature. The thermostat will do the rest. You do not have to calculate when the heating should start; *devireg*[™] 550 will do this for you.

The DEVI™ Warranty:

You have purchased a **deviheat™** 550 thermostat, which forms an integrated part of a **deviheat™** system, which we are certain will improve your home comfort and economy.

deviheat™ provides complete heating solutions with **deviflex™** heating cables or **devimat™** heating mats, **devireg™** thermostats and **devifast™** fitting bands.

If, however, contrary to all expectations, a problem should occur with your heating system, we at **DEVI™**, with manufacturing units in Denmark, are, as European Union suppliers, subject to general product liability rules, as stated in Directive 85/374/CEE, and all relevant national laws which implies that:

DEVI™ provides a warranty for **deviflex™** heating cables and **devimat™** heating mats for a 10 year period and all other **DEVI™** products for a 2 year period against defects in material and production. The guarantee is granted on the condition that the WARRANTY CERTIFICATE on the overleaf is filled out properly in accordance to instructions and that the defect is inspected by, or presented to, **DEVI™** or authorised **DEVI™** distributor.

Please note that the wording of the WARRANTY CERTIFICATE must be provided in English or local language with the ISO code for your country in the upper left

corner of the front page of the installation instructions in order to release the warranty.

The obligation of **DEVI™** will be to repair or supply a new unit, free of charge to the customer, without secondary charges linked to repairing the unit.

In case of defective **devireg™** thermostats, **DEVI™** reserves the right to repair the unit free of charge and without unreasonable delay to the customer.

The DEVI™ warranty does not cover installations made by unauthorised electricians, or faults caused by incorrect designs supplied by others, misuse, damage caused by others, or incorrect installation or any subsequent damage that may occur. If **DEVI™** is required to inspect or repair any defects caused by any of the above, then all work will be fully chargeable.

The DEVI™ warranty is void, if payment of the equipment is in default.

At all times, we at **DEVI™** will respond honestly, efficiently and promptly to all queries and reasonable requests from our customers.

The above mentioned warranty concerns product liability whereas matters in relation to legislation on sale of goods shall be referred to national law.

Warranty Certificate

The DEVI™ Warranty is granted to:

Name:

Address:

Postal code:

Phone:

Please Observe!

In order to obtain the DEVI™ Warranty, the following must be carefully filled in. See other conditions on the overleaf.

Electrical Installation by:

Installation date:

Type of thermostat:

Production code:

Suppliers Stamp:

DE-VI Electroheat Ltd.

Bury St. Edmunds

Suffolk IP30 9QS

Phone 1359 24 24 00

Fax 1359 24 25 25



Connection diagram:

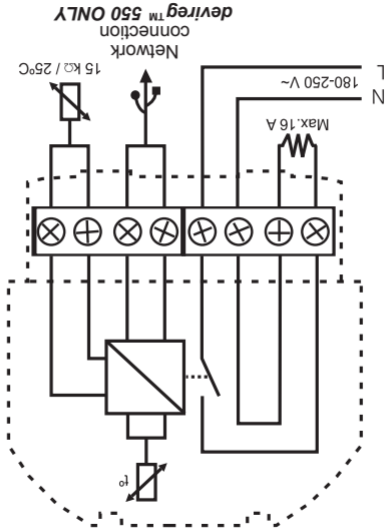

Technical specifications:

Temperature range:	+5° to +35°C or OFF
Floor temperature limit:	+20° to +50°C
Voltage:	180 V - 250 V ~ 50/60 Hz
Resistive load:	250 V ~ 16 A
Inductive load:	1 A (power factor 0.3)
Power consumption:	> 500 mW
Battery back-up:	100 hours
Economy set-back:	0° to -15°C
Offset:	-5.5° to +5.5°C
IP class:	IP 30
Type of sensor:	NTC
Sensor value:	15 kOhm / 25°C

No: Fault:

2 Configured as Master, but can detect another Master unit
Only one unit may be configured as a Master

6 Sensor fault
Sensor fault
floor sensor open circuit
Change the floor sensor

5 Sensor fault
Sensor fault
floor sensor shortcircuit
Change the floor sensor

Error messages:

devireg™ 540/550 has a built-in system that constantly checks the heating system, the thermostat itself and a possible network for any malfunctions. If an error occurs, the display will flash together with a reading of the detected fault, which will be shown indicated by the weekday numbers 1 to 7:

<u>No:</u>	<u>Fault:</u>	<u>What to do:</u>
7	Clock is not adjusted	Set the clock
4	The thermostat is switched off because of overheating	Let the thermostat cool for a period. Then enter basic setup to leave fault mode
3	Configured as a Slave, but cannot find any Master unit	One unit must be configured as Master

If more master units are configured on the network, an error message will flash in the display, and the unit will need to be reconfigured.

If a **devireg™ 550** is configured as a slave unit, the following set-up parameters are controlled from the master unit:

- Time
- Day of week
- C° or F°
- 12 hour AM/PM or 24 hour clock
- Set back program

Network accessories:

Network cable
15881150

Single core 0,75 mm²
(100 m)

Network connections (devireg™ 550 ONLY):

The devireg™ 550 features a network capability.

All devireg™ 550's installed in a building can be linked together via the network facility, giving the possibility of central adjustment of programming and parameters e.g. clock setting.

The network can include up to 32 units, i.e. 1 master and up to 31 slave units.

It is only possible to have one master unit.

A devireg™ 550 can be set as a stand alone unit, even

though it is connected to the network. It will not respond to or send information to a master unit, but it will count as one of the maximum 32 units in the network.

The network is a separate two wire net, where the cables are unshielded, untwisted and unpolarised for easy installation.

The maximum length of the network cables are up to 500 metres.

Factory setting:

The thermostat is preset with the following parameters:

<u>Operation</u>	<u>Factory setting</u>	<u>Choices</u>
Network type	Alone	Alone, Master or Slave
Temp. display	C°	C° or F°
Sensor	Room + floor	Room, floor or room + floor
Max. floor temperature	+45°C	+20°C to +50°C
Offset	0.0°C	-5.5°C to +5.5°C
Economy set-back	-5°C	-1° to -15°C
Weekday	1	1, 2, 3, 4, 5, 6, 7
Clock	24	12 hours AM/PM or 24 hours
Time	--:--	--:--
Timer settings	-	Up to 336/week



To finish the basic setting, press the daily operation menu.

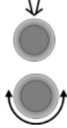

Turn to choose **12** or **24** hours, and press ...



Finally, the type of clock must be set. Choose whether the clock must be 24 hours or 12 hours AM/PM.

In connection with the built-in Timer, the thermostat can be programmed to lower the temperature (LO), e.g. during the night.

The range is 0°C to -15°C.

Turn to choose economy set-back level, and press ...

(Choose -5°C if the temperature must be lowered 5 degrees).

If normal room heating is installed we recommend not to lower the temperature at night with more than approx. -5°C.

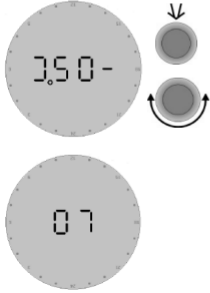

Offset (OFFS) can be used to adjust a variation between the thermostat and a thermometer in the room, if any. If the thermometer shows e.g. 1°C more than the thermostat, it is possible to adjust the offset with +1°C. The range is -5.5°C to +5.5°C.

Turn to choose offset, and press ...

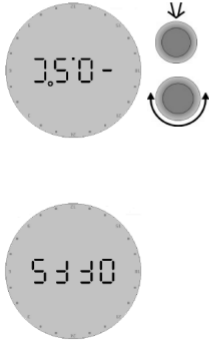



Due to different floor constructions it is possible to choose a maximum floor temperature (**Mt**) in the floor which cannot be exceeded.
The temperature range is 20°C to 50°C.

Turn to choose maximum floor temperature, and press ...

Please note!

Maximum floor temperature is preset

from the factory to 45°C for cable temperature safety.

Local building regulations must be observed, when changing the maximum preset temperature.

For wooden floor constructions **DEVI™** recommend to limit the temperature to maximum 27°C.

Max. temperature setting for different floor constructions i

27°C	Tiles on chipboard
35°C	Carpet/vinyl on chipboard
27°C	Wooden floors (parquet, plank, etc.)
45°C	Other (concrete, screed, etc.)

devireg™ 540/550 is able to use two sensors, one built-in sensor plus an external sensor which can be placed e.g. in the floor.
Choose the sensor(s) which will be used for this heating system.

Turn to choose Room Sensor (**rS**), Floor Sensor (**fS**) or both Room and Floor Sensor (**rFS**), and press ...

(If the thermostat only uses a floor sensor, the display will not show the actual temperature (5° to 35°), but a scale from 0 to 10).

Always use a floor sensor when the heating element is installed on or beneath wooden surfaces !

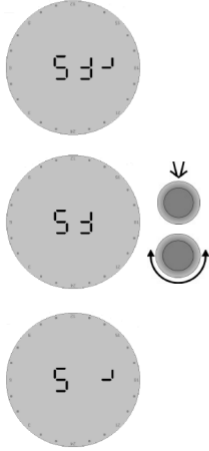

Choose whether the thermostat must show Celsius or Fahrenheit degrees. Turn to choose **C°** or **F°**, and press ...

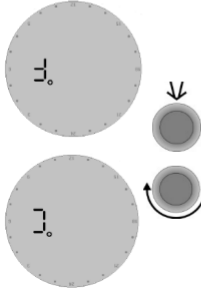

devireg™ 550 ONLY:

The first function to choose in the basic setting is whether **devireg™** 550 must operate Alone or as Master or Slave thermostat.
If several thermostats are linked in one network, only one of the thermostats can be chosen as Master !

For further information about network and Master/Slave, see section on page 24.

Turn to choose Alone (**ALO**), Master (**MAS**) or Slave (**SLA**), and press ...

Please note !

If Slave is chosen, not all settings in the Basic Setting will appear.
The settings left out can be set from the Master unit.

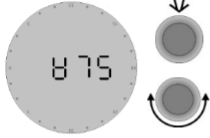

Change of basic setting

If it is necessary to change the basic setting, the button must be held for 12 sec.

It is then possible to access the basic setting menu by choosing the code !

Turn to choose code ...

Choose the code: 0044

When the code is chosen, press the button ...

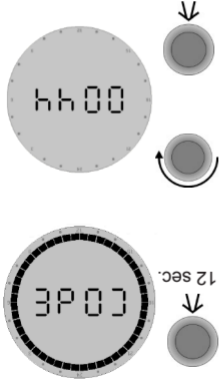

devireg™ 540/550 is able to use two sensors, one built-in sensor plus an external sensor which can be placed in the floor.
Choose the sensor(s) which will be used for this heating system.



Turn to choose Room Sensor (**rS**), Floor Sensor (**FS**) or both Room and Floor Sensor (**rFS**), and press ...

(If the thermostat only uses a floor sensor, the display will not show the actual temperature (5° to 35°), but a scale from 0 to 10).

Always use a floor sensor when the heating element is installed on or beneath wooden surfaces !

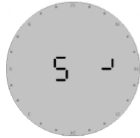

Activating device™ 540/550

When the thermostat is connected to the mains voltage for the first time, a code must be chosen and the sensor(s) selected.

Turn to choose code ...

Choose the code: 0044

When the code is chosen, press the button ...

Now the sensors to be used, should be selected ...

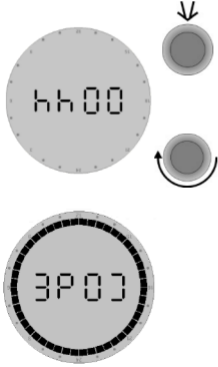

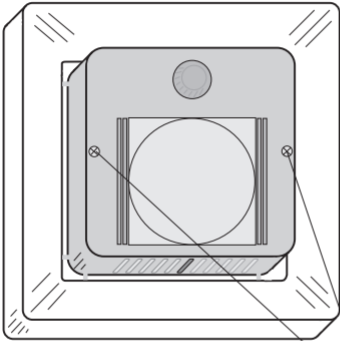

DO NOT over tighten !

Reassemble the thermostat by first placing the frame, then mount the display module and finally press the front cover into place.

Note:

The display must be gently remounted on the base module, ensuring that the 8-pin plug is placed accurately by using the four tabs surrounding it.

When remounting the two screws in the side, please DO NOT over tighten them. They just need to be barely fastened.

For getting the best possible result when using the **devireg™** 540/550, the thermostat should be installed in the wall, following a few basic

- rules:
- Installation height, typically between 80-150 cm.
- On a wall NOT facing the outside.
- On a wall where it will NOT be subjected to direct sunlight.
- Away from windows/doors that will be open occasionally.
- On a wall where it will NOT be covered by curtains, towels etc. hanging in front of the thermostat.

Warning (devireg™ 550 ONLY):

Please note, when working on thermostats connected to a network, ensure that the mains supply for all thermostats in the network is disconnected before the work is started.

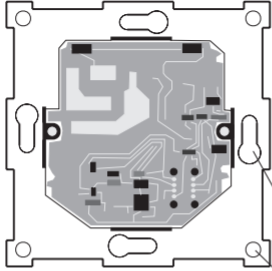

Screw holes

You can now mount the thermostat in the wall, by using any of the eight screw holes in the base module.

When installing the **devireg™ 540/550** you need to choose the type of heating and thus which sensors should be used.

DEVI™ recommend always to install the floor sensor !

Comfort Heating:

- Constant temperature on the floor in e.g. bathrooms and other rooms that are often used with bare feet.
- Install the Floor sensor and choose only the Floor sensor in Basic Settings:

Total Room Heating:

- Control of room temperature in living rooms etc.
- Install the Floor sensor and choose both Floor sensor and Room sensor in Basic Settings.

No Floor Sensor:

- A floor sensor is not present, and cannot be installed.
- Choose Room sensor only in Basic Settings.
- Be aware that temperature control is less accurate without the floor sensor. **DEVI™** recommend that a floor sensor is installed.

Do NOT use devireg™ 540/550 without floor sensor when the heating element is installed on or beneath wooden surfaces !

Connection of the thermostat must be carried out as shown below.

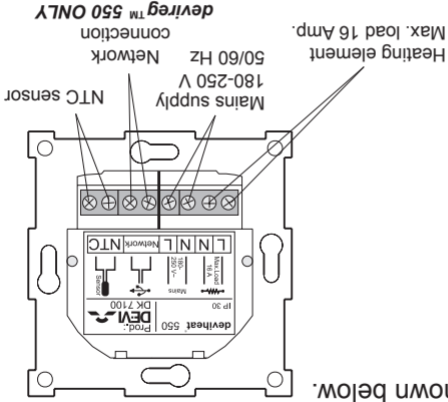

As the **devireg[™] 540/550** is not equipped with an earth terminal, the earthing screen of the heating cable must be connected to the earth from the supply via the earthing terminal in the surface mounted box or the recessed metal box which ever is used.

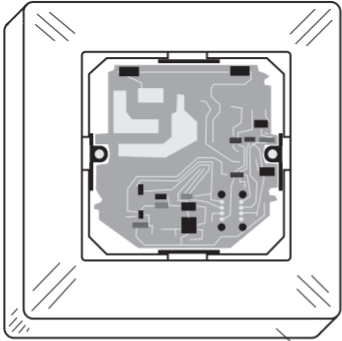

Frame

Remove the frame from the thermostat.

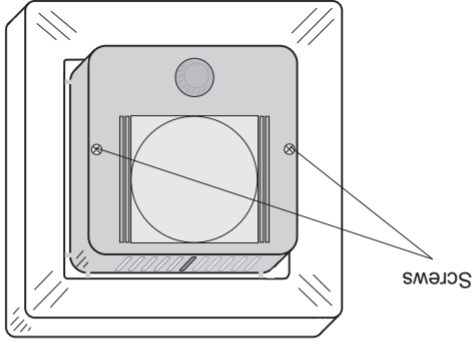

Remove the two screws, one in each side, and gently pull off the display module.

Installation of device™ 540/550:

When installing device™ 540/550 you must first dismantle the thermostat.

Remove the front cover by gently pressing the release tab in the top (center hole), and lift out the cover.

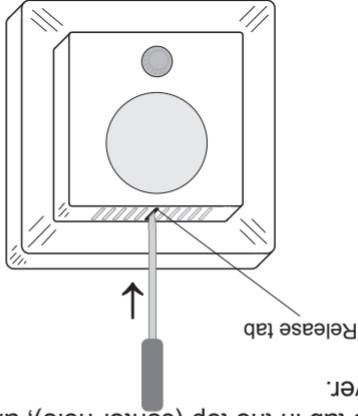

Table of contents	
Installation of devireg™ 540/550	4

Activating devireg™ 540/550	13
------------------------------------	----

Change of basic setting	15
-------------------------	----

Factory settings	23
------------------	----

Network	24
---------	----

Error messages	26
----------------	----

Technical specifications	28
--------------------------	----

Connection diagram	29
--------------------	----

Please Note:

The **devireg™** 540/550 must be connected and the basic

setting must be done by an authorised electrician.

Inappropriate installation and basic setting may cause damage to the heating system or floor construction.



devireg™ 540/550

Installation Instruction

GB